

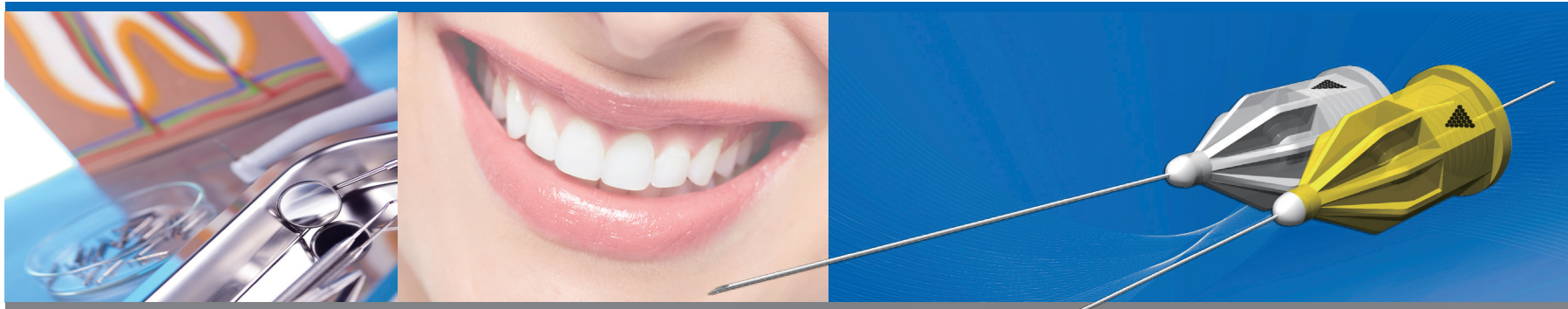

World Wide Primium Dental Materials, Devices



HIGHEST QUALITY DISPOSABLE DENTAL DEVICE

- **DENTAL INJECTION NEEDLES**
- **ENDODONTIC IRRIGATION NEEDLES**
- **IRRIGATION NEEDLES**
- **MEDICAL NEEDLES**

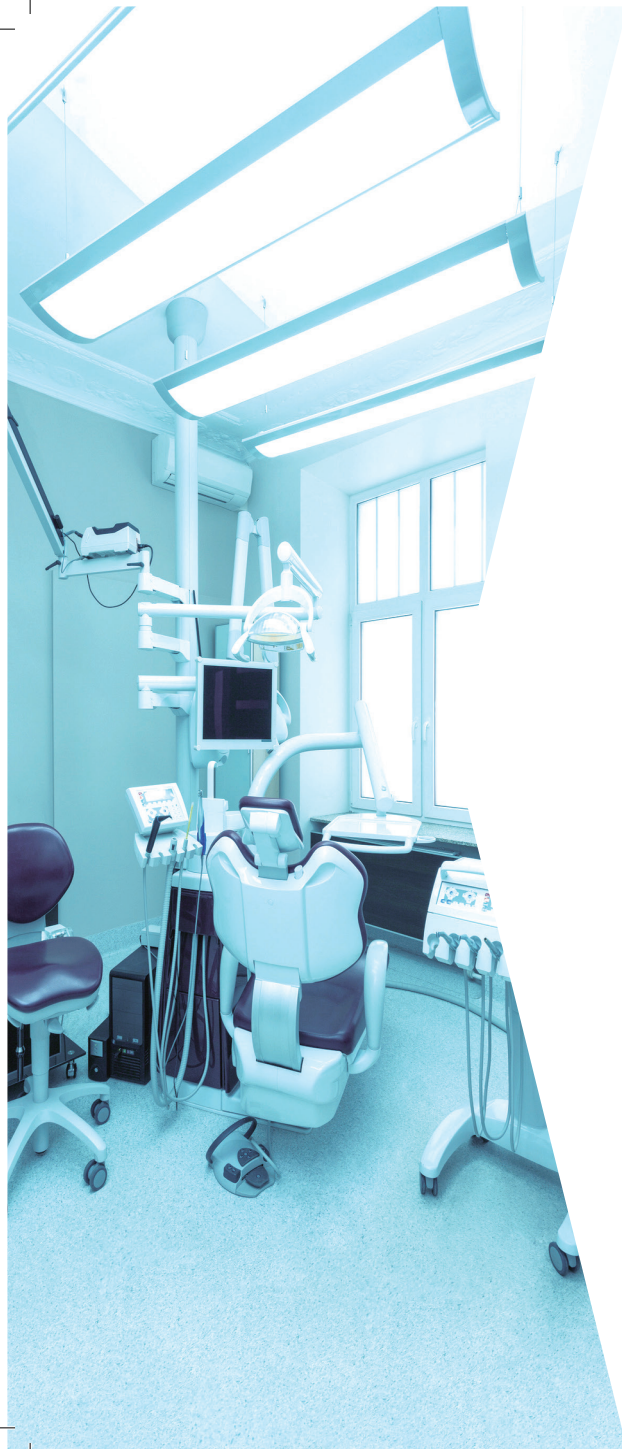

History

- 1998.7 : Established ShinWoo corporation(Medical / Dental)
- 2001.12 : Certified by CE 0120(S.G.S-U.K)-C54249(DIRECTIVE 93/42/EEC)
- 2003.7 : Dental DIV. divided as new firm manufacturing license no.(KFDA1777)
- 2004.11 : Certified by CE 0050(NSAZ) ISO9002, EN46002, ISO13488
- 2005.1 : Certified by CE 0120(S.G.S-U.K) ISO9001, ISO13485
- 2005.10 : Registered on FDA(USA)
- 2006.3 : Certified by CMDCAS
- 2007.6 : Certified by KGMP
- 2011.7 : Registered on JAPAN

Company Profile

“Since we were founded with the belief,” “The product we manufacture will be used for Our family”, in 1998, we, making our efforts to satisfy the customers with the best quality and reasonable price” in the fields of medical devices and dental needles, have been supplying the safest and most reliable product through the full automatic production line. We are manufacturing the best products not only through the strict quality verification on every production step from the raw materials to the completed products but also through the quality control by the clean room system.

We gained CE(0120) from SGS U.K in December of 2001 in the aspect of the external quality recognition, so that we could intensify our external reliability on our products. With such certificate, we are continuously making our efforts to satisfy our customers. We, Shinwoo Corporation, separated the dental division from our company and newly launched it as C-K Dental Ind. Co. Ltd in August of 2003 to improve the image as a more specialized company in the field of dental needle and positively exploit the business fields. We believe that our newest high-tech full automatic production system attributes to manufacturing the perfect high quality products that are safer and more even than any other companies' products in the world. Also on our dental needle, we gain ISO9002, EN46002 and ISO 13488 KFDA besides CE in November of 2004 and ISO9001, EN46002 and ISO 13485 by SGS(CE0120) in January of 2005, October.2005. Registered on FDA(USA) and June 2007. Certified by KGMP so that our products can be “the best choice” for you, the customers.”

We promise that we will be the most reliable business partner for you providing you with the best products and support that do not change all the time.
For more information, please do not hesitate to contact us any time.



MEDICAL / DENTAL 주사침 전문기업

Medical Needles, Single Use

- Hypodermic, meso therapy needles

Dental Injection Needles, Single Use

- Tri-bevel point, perfected treatment of surface protect the gum without damage of tissue
- The most strict grinding angle, ratio of tri-bevel points reduce pain
- The highest quality of siline coating substnially reduces pain smooth repeated injection

Endodontic Irrigation Needles

Irrigation Endo Probe of CK Dental with perfect surface processing "through highly precise technology and well rounded close tip." "It is safe and perfect for periodontal pockets irrigation as well as root canal Irrigation." And effectiveness is maximized compare to the existing product.

Root Canal Clean

"Unlike existing single side vent Product. CK Root Canal side Both Port Product" has a hole in both sides which reduces risk caused by the high pressure "of irrigating solution (NaOCI, Saline) during root canal irrigation, and maximizes perfect irrigation."

Periodontal Pocket Irrigation

"With the best technical knowhow, closed end of the product is process" "process to be perfectly well rounded, which enables to eliminate bacteria and toxin" without tissue damage during periodontal pocket irrigation.

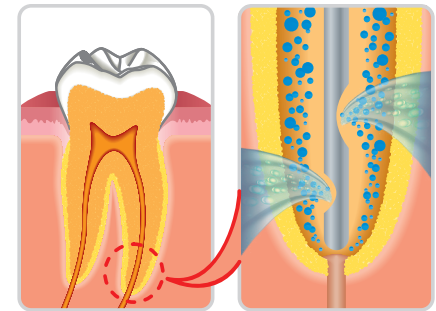
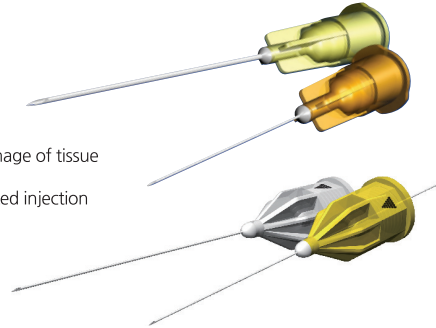

Irrigation Needles

전세계 90여개국 수출

치과용 주사침의 본고장 미국 · 일본 · 유럽 등에 품질의 우수성을 인정 받으며 수출하고 있습니다.

국내 최초 DENTA NEEDLE

- 31G X 12mm출시(침관 0.25mm)
수입제품에 의존하던 국내 시장을 당당히 우리 제품으로 대체
- 30G X 30mm(Ex.Long)출시
27G LONG(30mm)를 대체하는 제품으로 환자의 통증 완화

국내 최초 ENDO NEEDLE, DOUBLE SIDE VENT 출시

주로 수입제품에 의존하던 ENDO NEEDLE을 출시하여 저렴하면서도 고품질의 제품 공급, 특히 기술적으로 어려움이 많아 선진국에서도 쉽지 않았던 DOUBLE SIDE VENT(구멍 2개) 제품을 출시, 일본·유럽시장에 생산량의 70% 이상을 수출하고 있습니다.

최고의 know-how와 기술!
Needle 전문기업!!



• Design of ergonomical cap.

• Electric discharge of all products on hub hole.

• Special design for effectiveness of sterilization.

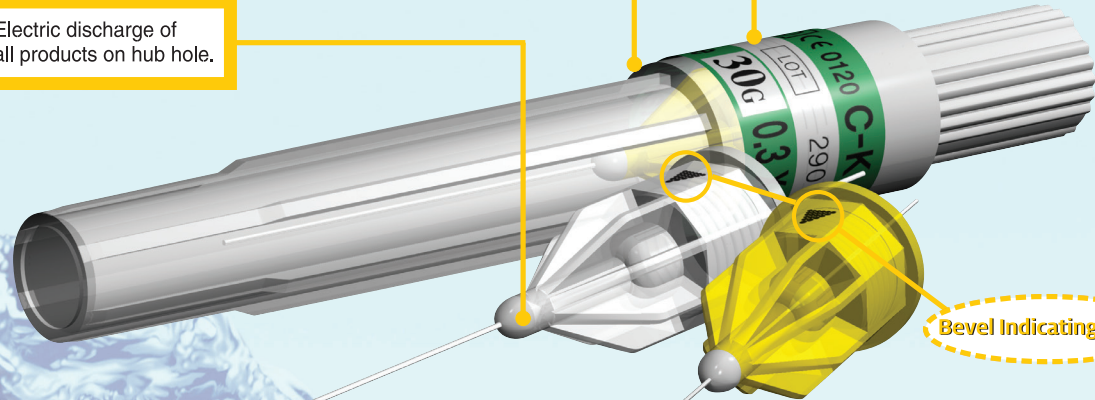

Bevel Indicating mark

• Tri-bevel point, perfected treatment of surface protect the gum without damage of tissue

• The most strict grinding angle, ratio of tri-bevel points reduce pain
• The highest quality of siline coating substantially reduces pain and smooth repeated injection

• Special heat treatment of tube makes C-K ject super-elastic

▮ 완벽한 표면처리, 잇몸조직의 손상과 통증을 최소화하는 **이상적인 연마각도!**

▮ 바늘표면의 **실리콘코팅**과 **특수열처리**로 수 차례의 Injection에도 부드럽게 삽입!

▮ **국내 최초 31G(0.25mm)**제품 식약청허가 및 양산!

▮ **국내 및 해외 최초! 수출마취 전용 30G X-Long(30mm)** 개발!

▮ 총생산량의 95%를 수출하고 있으며 미국, 캐나다, 영국, 이태리 등 유럽을 비롯한 **전세계 80여 개국에서 최고의 품질로 인정**

C-K MEDICAL / DENTAL NEEDLE POINT

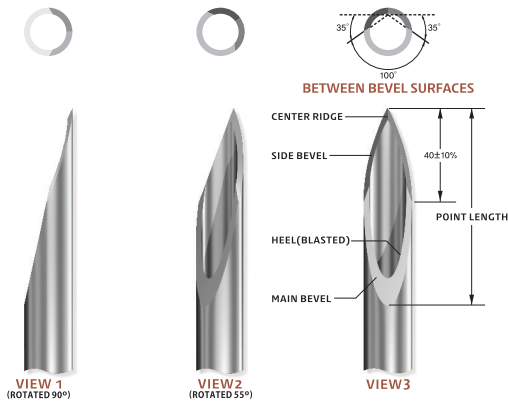

- Design of ergonomical cap.
- Special design for effectiveness of sterilization.
- Electric discharge of all products on hub hole.
- Tri-bevel point for easy tissue penetration without coring.
- The round cutting edge protecting the gum
- The most strict grinding angle, ratio of tri-bevel points reduce pain
- The highest quality of siline coating substantially reduces pain and smooth repeated injection.
- Special heat treatment of pipes makes super-elastic
- Bevel Indicating mark

DENTAL INJECTION NEEDLES



SIZE		REF No. (INCH : I, METRIC : M)
27G (0.4)	21mm	CK27-21-I(M)
	25mm	CK27-25-I(M)
	30mm	CK27-30-I(M)
	35mm	CK27-35-I(M)
	38mm	CK27-38-I(M)
	40mm	CK27-40-I(M)
30G (0.3)	12mm	CK30-12-I(M)
	16mm	CK30-16-I(M)
	21mm	CK30-21-I(M)
	25mm	CK30-25-I(M)
31G (0.25)	30mm	CK30-30-I(M)
	8mm	CK31-8-I(M)
	12mm	CK31-12-I(M)



DENTAL INJECTION NEEDLES



SIZE		REF No. (INCH : I, METRIC : M)
27G (0.4)	21mm	HG27-21-I(M)
	25mm	HG27-25-I(M)
	30mm	HG27-30-I(M)
	35mm	HG27-35-I(M)
	38mm	HG27-38-I(M)
	40mm	HG27-40-I(M)
30G (0.3)	12mm	HG30-12-I(M)
	16mm	HG30-16-I(M)
	21mm	HG30-21-I(M)
	25mm	HG30-25-I(M)
	30mm	HG30-30-I(M)
31G (0.25)	8mm	HG31-8-I(M)
	12mm	HG31-12-I(M)



ENDODONTIC IRRIGATION NEEDLES





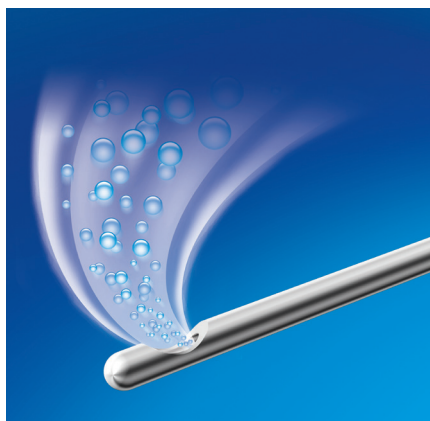

**Endodontic Needle -
Half Cut**
(End-Side Open)

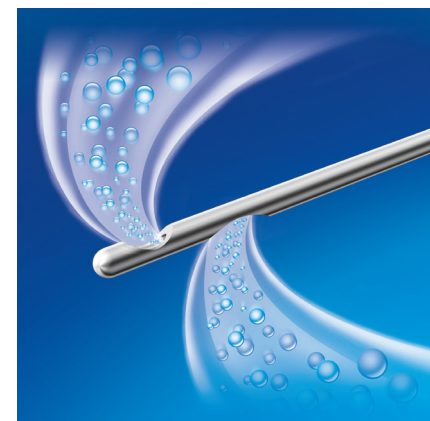

**Endodontic Needle Tip -
Single Side Vent**
(End Close -Side One Port)



**Endodontic Needle Tip -
Double Side Vent**
(End Close -Side Two Ports)

IMAGE	Gauge(G)	Size(L)	Color
	21G (0.8mm)	25mm, 32mm	Green
	23G (0.6mm)	25mm, 32mm	Blue
	25G (0.5mm)	25mm, 32mm	Orange
	27G (0.4mm)	25mm, 32mm	Medium Grey
	30G (0.3mm)	25mm, 32mm	Yellow

MODEL(SIZE) & REF No.

Half Cut		Single Side Vent		Double Side Vent	
SIZE	REF No.	SIZE	REF No.	SIZE	REF No.
30G × 25(32)mm	ED30-25(32)-H	30G × 25(32)mm	ED30-25(32)-S	30G × 25(32)mm	ED30-25(32)-D
27G × 25(32)mm	ED27-25(32)-H	27G × 25(32)mm	ED27-25(32)-S	27G × 25(32)mm	ED27-25(32)-D
25G × 25(32)mm	ED25-25(32)-H	25G × 25(32)mm	ED25-25(32)-S	25G × 25(32)mm	ED25-25(32)-D
23G × 25(32)mm	ED23-25(32)-H	23G × 25(32)mm	ED23-25(32)-S	23G × 25(32)mm	ED23-25(32)-D
21G × 25(32)mm	ED21-25(32)-H	21G × 25(32)mm	ED21-25(32)-S	21G × 25(32)mm	ED21-25(32)-D

IRRIGATION NEEDLES



Irrigation Blunt Needle Bent Tip - Straight Tip

Gauge	SIZE	Color	A+B	ANGLE
16G (1.6mm)	13, 15, 25, 32mm	Transparent	4mm + 9mm	25° ± 2°
17G (1.4mm)	13, 15, 25, 32mm	Red Violet	5mm + 10mm	30° ± 2°
18G (1.2mm)	13, 15, 25, 32mm	Pink	7.5mm + 7.5mm	45° ± 2°
19G (1.1mm)	13, 15, 25, 32mm	Cream		
20G (0.9mm)	13, 15, 25, 32mm	Yellow / Black		
21G (0.8mm)	13, 15, 25, 32mm	Green		
22G (0.7mm)	13, 15, 25, 32mm	Black		
23G (0.6mm)	13, 15, 25, 32mm	Blue		
24G (0.55mm)	13, 15, 25, 32mm	Purple		
25G (0.5mm)	13, 15, 25, 32mm	Orange / Black		
26G (0.45mm)	13, 15, 25, 32mm	Brown		
27G (0.4mm)	13, 15, 25, 32mm	Medium Grey		
28G (0.36mm)	13, 15, 25, 32mm	Blue Green		
29G (0.33mm)	13, 15, 25, 32mm	Red		
30G (0.3mm)	13, 15, 25, 32mm	Yellow		

• Bending Type Blunt

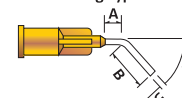

• Straight Type Blunt

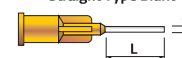

※For composite resin For Etchant

MODEL(SIZE) & REF No.

BENT TYPE		STRAIGHT TYPE	
SIZE	REF No.	SIZE	REF No.
16G × 13(15)mm	IR16-13(15)-BT	16G × 13(15, 25, 32)mm	IR16-13(15, 25, 32)-ST
17G × 13(15)mm	IR17-13(15)-BT	17G × 13(15, 25, 32)mm	IR17-13(15, 25, 32)-ST
18G × 13(15)mm	IR18-13(15)-BT	18G × 13(15, 25, 32)mm	IR18-13(15, 25, 32)-ST
19G × 13(15)mm	IR19-13(15)-BT	19G × 13(15, 25, 32)mm	IR19-13(15, 25, 32)-ST
20G × 13(15)mm	IR20-13(15)-BT	20G × 13(15, 25, 32)mm	IR20-13(15, 25, 32)-ST
21G × 13(15)mm	IR21-13(15)-BT	21G × 13(15, 25, 32)mm	IR21-13(15, 25, 32)-ST
22G × 13(15)mm	IR22-13(15)-BT	22G × 13(15, 25, 32)mm	IR22-13(15, 25, 32)-ST
23G × 13(15)mm	IR23-13(15)-BT	23G × 13(15, 25, 32)mm	IR23-13(15, 25, 32)-ST
24G × 13(15)mm	IR24-13(15)-BT	24G × 13(15, 25, 32)mm	IR24-13(15, 25, 32)-ST
25G × 13(15)mm	IR25-13(15)-BT	25G × 13(15, 25, 32)mm	IR25-13(15, 25, 32)-ST
26G × 13(15)mm	IR26-13(15)-BT	26G × 13(15, 25, 32)mm	IR26-13(15, 25, 32)-ST
27G × 13(15)mm	IR27-13(15)-BT	27G × 13(15, 25, 32)mm	IR27-13(15, 25, 32)-ST
28G × 13(15)mm	IR28-13(15)-BT	28G × 13(15, 25, 32)mm	IR28-13(15, 25, 32)-ST
29G × 13(15)mm	IR29-13(15)-BT	29G × 13(15, 25, 32)mm	IR29-13(15, 25, 32)-ST
30G × 13(15)mm	IR30-13(15)-BT	30G × 13(15, 25, 32)mm	IR30-13(15, 25, 32)-ST

MEDICAL NEEDLES HYPODERMIC, MESO THERAPY NEEDLE



SIZE	Length COLOR	1 1/2" (38mm)	1 3/8" (35mm)	1 1/4" (32mm)	1" (25mm)	5/6" (21mm)	3/4" (19mm)	5/8" (16mm)	3/5" (15mm)	1/2" (13mm)	5/16" (8mm)	4mm
16G	Transparent	DNS 16-38	DNS 16-35	DNS 16-32	DNS 16-25	DNS 16-21	DNS 16-19	DNS 16-16	DNS 16-15	DNS 16-13	x	x
17G	Red Violet	DNS 17-38	DNS 17-35	DNS 17-32	DNS 17-25	DNS 17-21	DNS 17-19	DNS 17-16	DNS 17-15	DNS 17-13	x	x
18G	pink	DNS 18-38	DNS 18-35	DNS 18-32	DNS 18-25	DNS 18-21	DNS 18-19	DNS 18-16	DNS 18-15	DNS 18-13	x	x
19G	Cream	DNS 19-38	DNS 19-35	DNS 19-32	DNS 19-25	DNS 19-21	DNS 19-19	DNS 19-16	DNS 19-15	DNS 19-13	x	x
20G	Yellow	DNS 20-38	DNS 20-35	DNS 20-32	DNS 20-25	DNS 20-21	DNS 20-19	DNS 20-16	DNS 20-15	DNS 20-13	x	x
21G	Deep green	DNS 21-38	DNS 21-35	DNS 21-32	DNS 21-25	DNS 21-21	DNS 21-19	DNS 21-16	DNS 21-15	DNS 21-13	x	x
22G	Black	DNS 22-38	DNS 22-35	DNS 22-32	DNS 22-25	DNS 22-21	DNS 22-19	DNS 22-16	DNS 22-15	DNS 22-13	x	x
23G	Deep blue	DNS 23-38	DNS 23-35	DNS 23-32	DNS 23-25	DNS 23-21	DNS 23-19	DNS 23-16	DNS 23-15	DNS 23-13	x	x
24G	M.purple	DNS 24-38	DNS 24-35	DNS 24-32	DNS 24-25	DNS 24-21	DNS 24-19	DNS 24-16	DNS 24-15	DNS 24-13	x	x

MEDICAL NEEDLES HYPODERMIC, MESO THERAPY NEEDLE



SIZE	Length COLOR	1 1/2" (38mm)	1 3/8" (35mm)	1 1/4" (32mm)	1" (25mm)	"5/6" (21mm)	"3/4" (19mm)	"5/8" (16mm)	"3/5" (15mm)	1/2" (13mm)	"5/16" (8mm)	4mm
25G	Orange	DNS 25-38	DNS 25-35	DNS 25-32	DNS 25-25	DNS 25-21	DNS 25-19	DNS 25-16	DNS 25-15	DNS 25-13	DNS 25-8	DNS 25-4
26G	Brown	DNS 26-38	DNS 26-35	DNS 26-32	DNS 26-25	DNS 26-21	DNS 26-19	DNS 26-16	DNS 26-15	DNS 26-13	DNS 26-8	DNS 26-4
27G	M. grey	DNS 27-38	DNS 27-35	DNS 27-32	DNS 27-25	DNS 27-21	DNS 27-19	DNS 27-16	DNS 27-15	DNS 27-13	DNS 27-8	DNS 27-4
28G	Blue green	DNS 28-38	DNS 28-35	DNS 28-32	DNS 28-25	DNS 28-21	DNS 28-19	DNS 28-16	DNS 28-15	DNS 28-13	DNS 28-8	DNS 28-4
29G	Red Violet	x	x	x	DNS 29-25	DNS 29-21	DNS 29-19	DNS 29-16	DNS 29-15	DNS 29-13	DNS 29-8	DNS 29-4
30G	Yellow	x	x	x	DNS 30-25	DNS 30-21	DNS 30-19	DNS 30-16	DNS 30-15	DNS 30-13	DNS 30-8	DNS 30-4
31G	White	x	x	x	x	x	x	x	x	DNS 31-13	DNS 31-8	DNS 31-4
32G	Deep green	x	x	x	x	x	x	x	x	DNS 32-13	DNS 32-8	DNS 32-4
33G	Black	x	x	x	x	x	x	x	x	DNS 33-13	DNS 33-8	DNS 33-4

www.ck-dental.com



Standard ISO7885,8020(E)

- Needle Size : Standard for specification : ISO9626, ISO7864
- Color Code of Hub : ISO6009(1992)
- Labelling : Color Code -ISO6009(1992), Description of label-ISO8601
- Label Paper : Special coated paper for sterilization
- Sterilization : EN550 / ISO1135-1



C-K DENTAL IND.CO.,LTD.

88-50, SUDO-RO, BUCHEON-SI, GYEONGGI-DO, KOREA

경기도 부천시 수도로 88-50 씨케이덴탈산업(주) TEL : +82-32-679-1204/6

e-mail : ck-dental@hanmail.net FAX : +82-32-679-1207